



INDUSTRIAL VALVES FOR ALL APPLICATIONS





SODECO Valves, founded in 1989, is a trustworthy distributor of industrial valves and accessories suitable for the high demands of clients in industries such as chemical, petrochemical, paper and sugar.

Thanks to long standing relationships with our suppliers, we can offer a complete product range for all sorts of applications. Sodeco Valves has a large stock of ANSI and DIN valves, and having our own workshop, we can offer you hand operated valves with or without accessories and even fully automated valves.

We supply industrial valves such as:

- Ball valves
- Diaphragm valves and plug valves
- Globe valves
- Strainers
- Steam traps
- Safety valves, rupture discs
- Overflow valves and pressure reducing valves
- Butterfly valves
- Check valves
- Gate valves and knife gate valves
- Control valves and solenoid valves
- Pressure and temperature instrumentation
- Automation (pneumatic, electric, hydraulic) and accessories
- And so much more

Taking Control



HIGH QUALITY PRODUCTS, ADVICE AND SERVICES

From our main office in Ternat, Belgium we help companies select the valves that best suit their needs. Thanks to the know-how and commitment of our 50 experienced employees you can count on us for:

- **Assembling**
 - management
 - assembly and mounting
 - setting of limit switches and positioners
- **Projects**
 - comprehensive administration
 - consultation at your premises
 - technical advice
- **Documentation department**
 - 3D drawings
 - technical files
 - certificates
- **Testing department**
 - functional testing for all automated valves
 - adjustment of safety valves in collaboration with Apragaz, Vinçotte and others

STANDARD AND CUSTOM ASSEMBLIES

Our experts always guarantee you the best products and service, whether you need standard or customised materials. We have our own workshop for custom orders, where we are able to automate our products to fit your demands. All final products can come with a test certificate.

INTERNATIONAL REACH

Our central warehouse in Belgium of 4.500 m² has € 6 million worth of valves in stock. It's the reliable core of our international reach. Thanks to branches in Belgium, Holland, Germany and Switzerland we can deliver quickly all over Europe.

PREMIUM SERVICE

As an experienced and dynamic company we can guarantee products and advice of the highest quality. We also provide excellent and efficient service:

- fast quotation and order processing
- technical information in your language
- comprehensive digital connectivity
- advice from qualified staff



Taking Control



Contents

Ball valves	04-07
Butterfly valves	08-11
Knife gate valves	12-13
Gate valves	14-15
Globe valves	16-17
Check valves	18-19
Automation	20-25
Control valves	26-27
Strainers	28-29
Safety valves	30-31
Expansion joints	32-33
Tank protection	34-35
Steam equipment	36-37
Instrumentation	38-39
Sight glasses and level indicators	40
Diaphragm valves and pinch valves	41





Ball valves

In our large stock you will find a wide range of ball valves. We have ball valves in stock with many different connections: one and two-piece ball valves, threaded and flanged connections, three piece ball valves with threaded or weld connections to name a few.

Whether it's brass ball valves or trunnion mounted valves in exotic materials, we know them all. We also offer flanged ball valves in both DIN and ANSI in different materials. If you're looking for high quality ball valves with short lead times, you have found your partner with Sodeco Valves. As a partner of the Spanish JC Valves, among others, we can react quickly to cater to your short and medium term project needs.

We offer solutions for various industrial sectors and will find the right valve that's suitable for your specific requirements. Our range of different materials allows us to adjust to your wishes regarding pressure, temperature and fluid. We can offer customized solutions for high temperatures and cryogenic applications as well. Our ball valves are extensively certified, so various inspections such as Fire-Safe, TA-Luft and food inspection are possible.

Characteristics and possibilities

Full and reduced bore

1-, 2- and 3-piece

Mounting flange according to ISO 5211

Pressure class: DIN PN10 - PN16 - PN40 - PN64 / ANSI CLASS150 - CLASS300 - CLASS600 -

CLASS900 - CLASS1500 - CLASS2500 - and larger

Diameter: DN 15 - DN 250 / 1/2" - 12", larger diameters possible as trunnion valves

Connection: Flanges (RF, RTJ, ...) - Wafer type - Threaded (BSP - NPT) - Weld ends (SW - BW)

Special versions: Cryogenic valves (up to -196°C) - With heating jacket - Tank bottom valves - 3- and 4-way valves

Special materials possible on demand

Many different certifications available



Ball valves

3- and 4-way ball valves with various possibilities: L, T, X and I port. With threaded, welding or flanged connections.



SODECO Valves



We offer customized automation solutions. Together with the customer, we will check what the best solution is for your application. Ball valves in all shapes and sizes: 1-piece, 2-piece, 3-piece and wafer type. We have them in stock!





Some examples of trunnion mounted ball valves, available in different materials and pressure classes. On the image below you can see some double block & bleed valves. For the automation of larger diameters we choose scotch & yoke actuators.

Ball valves



SODECO Valves



Butterfly valves

With the Spanish manufacturer TTV as a partner, Sodeco Valves can offer you a wide range of high quality butterfly valves. These valves have been used for decades and with great success in all kinds of industries, such as : chemical, paper & pulp, food, water treatment, pharmaceutical, oil & gas, vacuum applications, HVAC, metallurgy, steam and many more.

Our soft seated concentric butterfly valves are available from stock in both wafer and lug versions. The seats are available in different materials, and even as PTFE or PFA coated versions.

Characteristics and possibilities

Butterfly valves with interchangeable seat: DN 32 up to DN 1200

In ANSI or DIN version

Types: Wafer-lug-flanged

Various body materials such as nodular cast iron, steel, stainless steel

Multiple material options for stem and disc, even PTFE/PFA coated.

Seat:

- EPDM
- Viton
- NBR
- EPDM for high temperatures
- Silicone
- ...



Butterfly valves



SODECO Valves

Butterfly valves



SODECO Valves

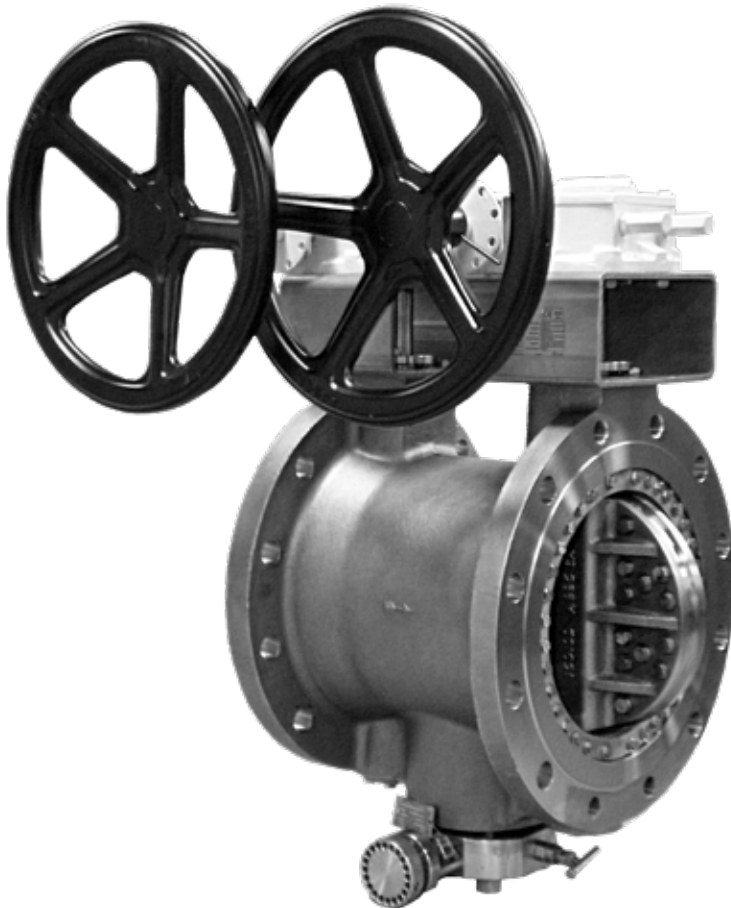

Other quality brands complete our product range for high performance butterfly valves, both double and triple offset. These valves can be ordered in a wide range of materials, with triple offset valves being made 100% to suit customer demand.

Double and triple offset butterfly valves are used in very demanding applications. Thanks to their advantage when it comes to weight, face to face dimensions and price, they can often prove to be an interesting alternative for other valve types.

These valves are available in different pressure classes and diameters. Options such as double block & bleed are also available.



All of our butterfly valves satisfy the expectations and needs of our customers:

- Perfect sealing, even in the most difficult operating conditions
- Reliable build quality
- Compact and clever construction for ease of maintenance
- Complete range
- Great durability
- Easy installation
- Excellent performance (Kv values, minimal pressure drop)
- Automation and special options are possible

Butterfly valves



SODECO Valves



Knife gate valves

Knife gate valves are used in lots of general and more specialized industrial applications. These range from difficult applications with contaminated fluids and gasses to the pneumatic transport of powders and granules. We have been partnered up with the Spanish CMO Valves for years, and can offer you a suitable knife gate valve for your application.

We have a large range of manual, pneumatic, hydraulic or electric variants. Knife gate valves for industrial applications are usually wafer types, and are available in cast iron, steel and stainless steel. The materials of packing, seat and gate can be adapted to your needs.

Our CMO knife gate valves have been developed, tested and produced with the latest technologies, and with ISO9001 quality certificate of course.

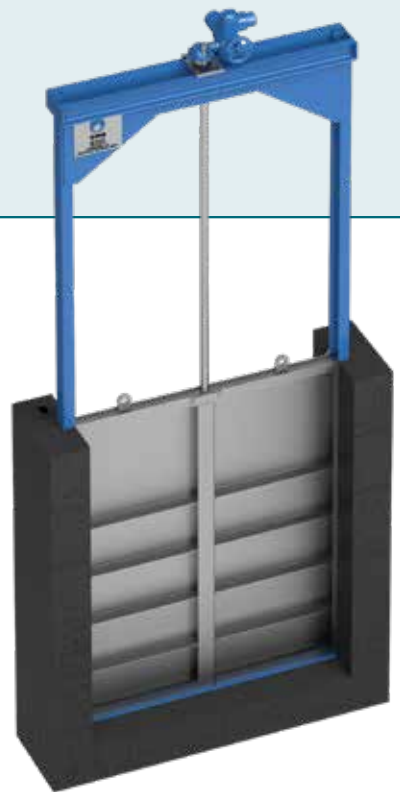

Applications

- Water treatment, waste water
- Silos
- Cement industry
- Powders and grains
- Paper & pulp
- Food industry
- Pneumatic transport
- Slurries and mining industry
- Pump stations





Gate valves

Gate valves are an industry standard and are used as on/off valves for many different applications, such as water, chemicals and oil & gas. The main advantage is the straight, full bore once the valve is fully opened. Depending on the application, Sodeco Valves can offer you versions with inside or outside stem, rising or non-rising handwheel and parallel gate or conical wedge.

ANSI (API) or DIN, cast or forged, brass, bronze, (nodular) cast iron, steel or stainless steel, Sodeco has a model for every application.



Gate valves

For applications with water, there are also versions available with rubber lined wedge.

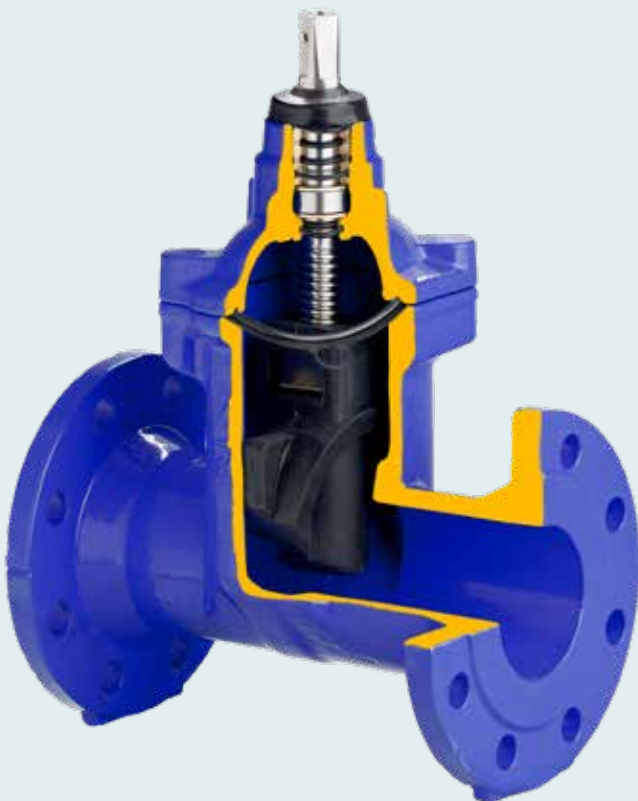

SODECO Valves



Globe valves

Sodeco also has a wide range of globe valves.

Alongside classic globe valves we also sell bellow seal valves. These are used for applications with steam or thermal oils. We can also propose valves with double bellow, for those critical applications. These valves are available in cast iron, nodular cast iron, cast steel, stainless steel or high quality alloys. We have products for all pressure classes (DIN/ANSI), and in different configurations. We can also offer these valves with pneumatic or electric actuators for on/off applications. Throttling discs or soft sealed versions with PTFE seal are also possible (flat disc – parabolic – throttling).

Applications

- Applications for oil & gas
- Power plants
- Steam
- Water
- Solvents and other chemicals



Globe valves

Bellow seal valves for thermal oils.



SODECO Valves



Check valves

Check valves ensure that the fluid only flows in one direction. It's completely self-operating, without the need for automation. We also have versions with soft seats for 100% sealing. With well-considered placement, this type of valve can be used in both horizontal and vertical pipelines.

Our check valves are available in bronze, (nodular) cast iron, steel and stainless steel. On request, even more exotic materials such as Hastelloy and Monel are possible.

You can contact Sodeco for different types of check valves:

- Wafer/flanged and threaded
- Swing check valves
- Spring loaded check valves
- Disc check valves
- Twin plate check valves
- Ball check valves
- Piston check valves
- Membrane check valves



Check valves

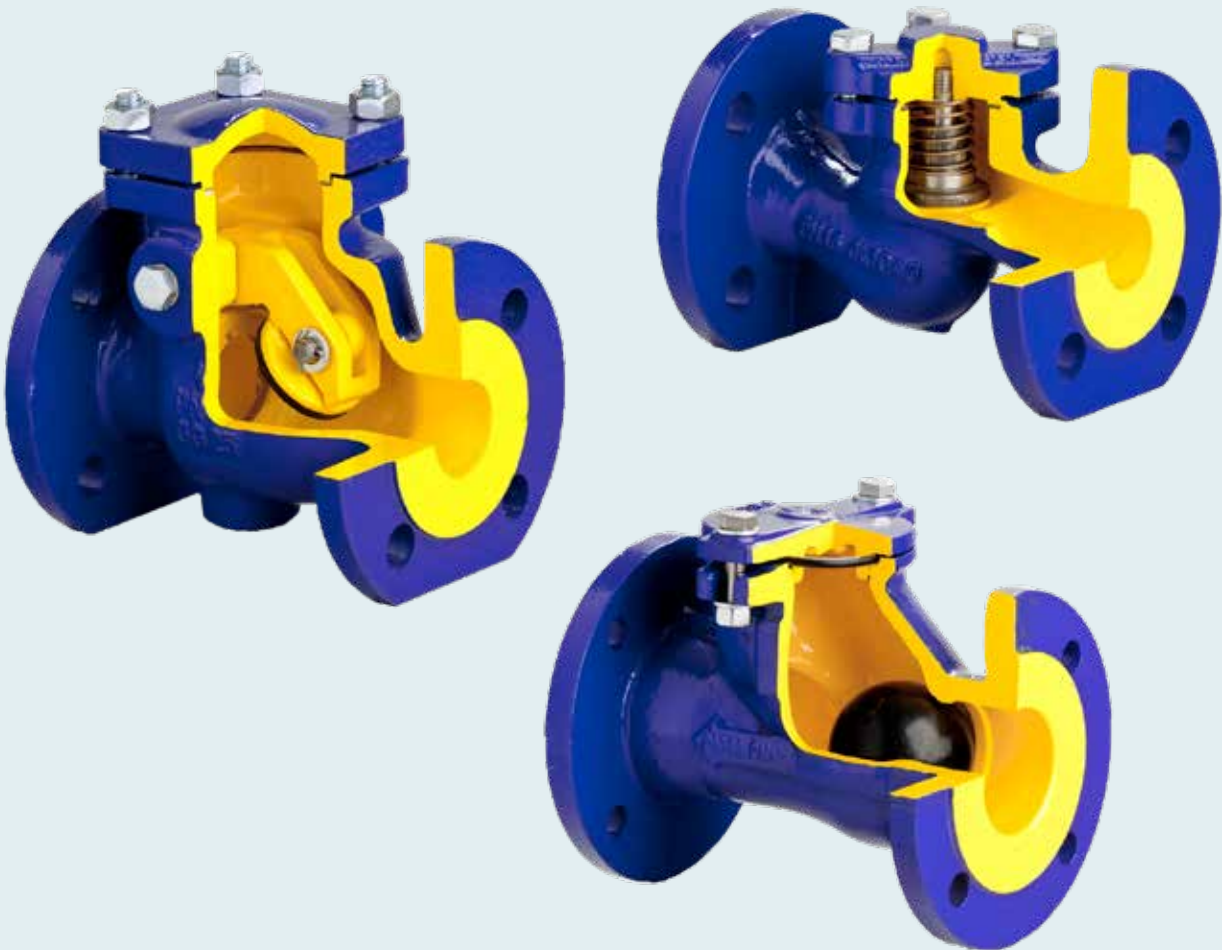

SODECO Valves



Automation

One of our trump cards is the many years of experience in valve automation. We can equip all of your valves with a suitable electric or pneumatic actuator. All accessories are assembled and tested in our workshop, from solenoid valves to limit switches (mechanical or proximity) and, of course, positioners.

Thanks to our large stock, we can offer you a complete solution in the shortest delivery time possible.



Pneumatic actuators

Rack and pinion principle for quarter turn valves.

- E-O-Matic
- Actreg

With standardized connections for simple installation and minimal maintenance, our actuators can be found everywhere in the industry.

Thanks to their high durability and low air consumption, our actuators contribute to a cost-effective installation. The design, using spring cartridges, ensures that springs can be swapped easily on-site.

Even when high torque outputs are needed, our Scotch/Yoke actuators can give you piece of mind, even in case of emergency (ESD - Emergency Shutdown Valve).





Electric actuators

Thanks to advanced production and material technologies, our electrical actuators can withstand all possible industrial environments. Thanks to their high precision, they can guarantee a maximal power output and optimal energy efficiency.

Complex applications demand sophisticated solutions. This is why, thanks to state of the art electronics, our electrical actuators are truly multi-purpose (fieldbus systems, preventative maintenance, data logging, partial stroke testing,...)

Naturally, both quarter turn and multi turn actuators have certain features as standard or available as optional extras (torque limiters, thermal protection, emergency signals,...) to ensure that your installation is safe, efficient and operable non-stop.

Some of the advantages of our actuators:

- For on/off and regulating purposes
- Easy and ergonomic operation
- Precise and reliable

We can offer actuators from several manufacturers.



Solenoid valves

To ensure that your quarter turn actuator works correctly, we can offer many different brands of solenoid valves. These are chosen together with the customer, while taking the process and the ATEX protection level into account.

- Bürkert
- Festo
- Norgren
- Asco-Joucomatic





Limit switches

It's very important to keep a close eye on your process, which is why we offer different possibilities to detect the position of your valves. We have plenty of sensors available for quarter turn and linear applications. Additionally, we can also supply limit switch boxes with mechanical or proximity switches for quarter turn applications:

- Pepperl & Fuchs
- Topworx
- ...





Positioners

To precisely control your pneumatically operated regulating valves, we can offer different types of positioners.

We can also provide various options matched to your application.

- ATEX explosion proof
- Fail Safe (for normally closed or normally open valves)

Other Additional options

- Locking and blocking systems available
- Analogue position indication 4-20 mA
- Speed controller
- Position indication (open & in box, mechanical or proximity, 2-wire or 3-wire, ...)
- Solenoid valves
- Interlocking systems between different valves
- Filter/pressure regulator
- Manual override
- Custom stem extensions
- Special anti-corrosion coatings





Control valves

Control valves are an essential element in any installation. This is why it's very important to choose the right one. Sodeco has a wide range of control valves for a multitude of applications.

Alongside standard 2- and 3-way control valves we can also offer more specialized versions. Possibilities include electrically or pneumatically operated valves with positioners, limit switches, filters/pressure regulators and more. These can, of course, be offered with compatibility for different field bus systems.

Sodeco can supply innovative solutions with high quality control valves in many versions and configurations. Contact us to discuss our possibilities.

- Available from DN 15 up to DN 400
- Eight million different product combinations
- Custom solutions for thermal and cryogenic applications
- Suitable for various applications such as water, steam, air, thermal oil, cooling fluids, gasses, natural gas and chemicals



Control valves



SODECO Valves

Strainers

To extract unwanted particles from your installation, Sodeco has a wide range of strainers to avoid contamination of the fluid.

Strainers are often a neglected or forgotten element, but are very much essential to ensure that every installation works correctly. If the strainer does not function as needed or has not been chosen correctly, the performance of the entire system will suffer from it.

From temporary strainers to simplex or duplex strainers, there is something available for each application. For larger capacities we can also supply basket strainers. If you're dealing with fine metallic particles, these can even be equipped with magnetic elements. Our strainers are available with threaded ends, weld ends or flanges.



Strainers

SODECO Valves



Safety valves and pressure relief valves

The safety of your staff and your installation are our biggest priorities! This is why Sodeco has partnered up with a number of renowned manufacturers to offer you all levels of protection against overpressure or negative pressure, for liquids, steam and gasses. An important factor is the correct sizing for your application. Let us assist you with decades of experience and using high quality products!

Our range includes safety valves as well as vacuum breakers and bursting discs.

Characteristics

Body: brass, bronze, cast iron, steel, stainless steel, special coatings

Disc/seat: Metal seated, Metal-PTFE, Metal-EPDM, Metal-Viton, Metal-Peek

Connection: BSP, NPT, flanged DIN and ANSI, clamped connections

Spring: Stainless steel, Chrome, Vanadium, Inconel

Options: with bellows, stellite seat, limit switches, nozzle ring ,...



Flanged safety valve for steam applications, with open bonnet and lever.





Expansion joints

If it doesn't bend, it breaks ...

Most piping systems have a solid structure. Solid metal or non-metal pipes join different components, including valves, together to complete the installation. However, since very few installations operate under constant temperature, thermal expansion can cause issues.

Expansion joints compensate for such expansion and contraction and reduce sound and vibration.

We can offer both rubber and metallic expansion joints. These can compensate for any axial and radial movement, depending on your process.



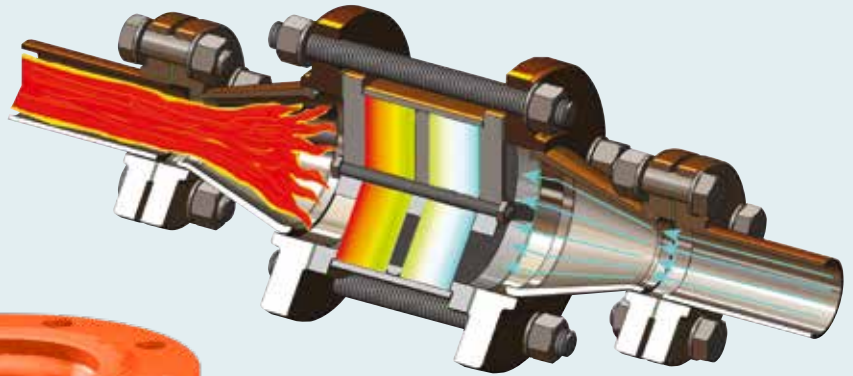

Vlammendovers: (Flame arresters)

Tank protection

Certain installations have a need for additional protection of their storage tanks.

Flame arresters:

When transporting flammable gasses through pipelines and storage tanks, it only takes one ignition source (spark, spontaneous combustion, static electricity, lightning strike, chemical reaction, ...) to cause disaster. A flame arrester is a passive safety element that lets gas or steam through, but stops any flames. The clever design of our flame arresters (Elmac) has a pressure drop that's up to 30% less than other manufacturers.

Tank blanketing valves

A tank blanketing valve injects an inert gas (usually nitrogen) in the space above the fluid in the tank when the pressure drops below a set value and will close when the pressure has reached an acceptable level. Using a nitrogen 'blanket' protects the fluid against contamination, as well as oxidation and evaporation.

Breather valves and pressure relief valves

Breather valves have been designed specifically to offer protection against overpressure or negative pressure when filling and emptying a tank. Our breather valves are 100% tight to avoid any fluid loss during this process. Thanks to the optimized design of the seat and pallet we can, in many cases, offer a smaller valve/DN.



Tank blanketing valves



Tank protection



Breather valves and flame arresters



SODECO Valves





Steam equipment

The efficiency of a steam installation mainly depends on the components it's comprised of. A good steam trap, for example, is essential for the correct energy management of the entire process. Our float, thermostatic or thermodynamic steam traps can be used in any application to avoid the loss of valuable steam. We also offer water separators, sight glasses, steam pressure regulators and much more, everything of equally high quality of course.

Applications for steam can be very demanding. This is why choosing the correct equipment is essential. Naturally we can also offer other manual or automated valves for steam applications, both saturated and overheated, alongside our dedicated steam equipment range.



Steam traps

Pressure reducing valves are essential components for steam installations.

Types:

- Direct acting
- Pilot operated

Versions:

- Steel
- Stainless steel
- High capacity
- Clean steam





Instrumentation

Alongside our wide range of valves and accessories, Sodeco Valves also has a selection of instrumentation equipment for temperature and pressure measurement, needle valves, fittings and much more. Pressure reducing valves are also a part of our range.



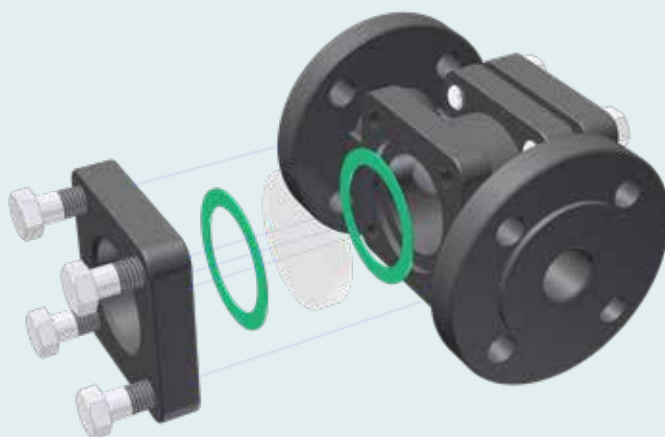

Sight glasses

Seeing is believing! Thanks to our sight glasses you can see if the fluid is actually passing through the pipeline. You can also check the fluid level in tanks or vessels with our level indicators, made to fit your tank and available with the necessary valves if needed.

Depending on your fluid, temperature and pressure we can offer a sight glass or level indicator that is suitable for your application.

Various versions available:

- Flanged versions
- Threaded connections,
- Weld ends
- Steel
- Stainless steel
- With borosilicate glass for high temperatures
- You can also choose various options, such as :
illuminated glass, with rotor, ...



Diaphragm and pinch valves

Diaphragm valves

Thanks to their design, diaphragm valves can be used where other types of valves would not be suitable or simply too expensive. There is a multitude of diaphragm materials which can also make them suitable for corrosive or abrasive applications. The diaphragm functions both as internal and external sealing.

Suitable for in-line maintenance, with optional position indicator and with an ergonomic handwheel, our diaphragm valves comply with the most recent and stringent industrial demands.

Sodeco can offer both weir and straight type valves with full bore and minimal pressure loss. These can be used for applications with slurries, for example.

All of our diaphragm valves can be ordered as a manual or an automated version, for applications with gasses or fluids.

Pinch valves

Pinch valves are especially suited for abrasive fluids, granules and powders. Slurries and emulsions don't pose any problems for these valves either. The full and straight bore guarantees maximum flow and minimal pressure loss. The lining (sleeve) can be made of many different elastomers, manufactured with the most modern production methods. They are of the highest quality and even comply with the strictest regulations in the food industry.

In case of very high operating frequencies, pinch valves can also be pneumatically operated.



Stock

From our central warehouse, 4500m² large, we can quickly and reliably ship our valves to customers all over Europe. We keep a stock of valves and accessories worth € 6 million, so we can react quickly to the specific needs of our customers. This allows us to keep delivery times as short as possible.

Valves ranging from 1/2" up to 24", different materials, pressure classes and diameters are all available from stock. When you require custom automated valves, we can usually provide a suitable solution within a few working days.

We offer many different possibilities concerning packaging and transport in agreement with the customer. Thanks to daily shipments we can supply your valves within 24 hours if needed.



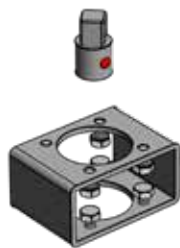

- Every valve is subjected to pressure tests after modification, so you can be sure the rebuild has been done according to a high standard.
- When a valve has been automated, every single assembly is subjected to a functional test before delivery.
- On demand, we can offer individual torque checks, specific pressure tests and more.

Stock

All of our products are assembled in our workshop. Thanks to our many years of experience in this field, we can offer numerous custom solutions on short notice.

Our own workshop

- Everything is done in-house, cost-effective
- Experienced staff
- Large stock of both components and mounting pieces
- Pressure and leakage tests can be done in-house, time efficient

SODECO Valves



Certificates

Every valve needs to comply with the applicable regulations and quality standards. Our certified products give our clients peace of mind, ensuring them that our products conform to the necessary regulations, in turn guaranteeing that our products will perform as the customer wishes and expects.

Material certificates, calibration certificates or food certificates are available, depending on the type of valve.

NDT (Non Destructive Tests) are also possible on request. Technical documentation or 2-D and 3-D drawings are readily available for a large part of our standardized products.

Thanks to a never ending product evolution, with in-depth R&D and certification, our clients can rest assured that their valves always comply to the strictest demands and latest technologies.

Sodeco valves are competitive, ergonomic, user friendly and reliable. Our many references over 3 decades can testify that.

The certifications to the right, among others, are available for our valves. Contact us to learn about the possibilities.



... And so much more ...

The short overview in this brochure gives you a first impression about our extensive product range, but there is so much more that we don't have room for here.

Special types, alternative versions, other options, other brands, custom solutions, ... in short: too much to name it all.

**Didn't find what you're looking for in this small overview?
Chances are we can provide it as well.
Contact us! It will be our pleasure to help you.**





Sodeco on the road!

When you are in need of advice when choosing the correct valves, you can always count on our knowledgeable staff. They will happily assist you in making the correct product choice. To do so, we can come and visit you with demo material. If desired, we can also give you and your staff advice regarding usage and maintenance of the different valve types.

We have plenty of demo material of our different products, and can present these to you on-site thanks to our custom demo units.

Notes

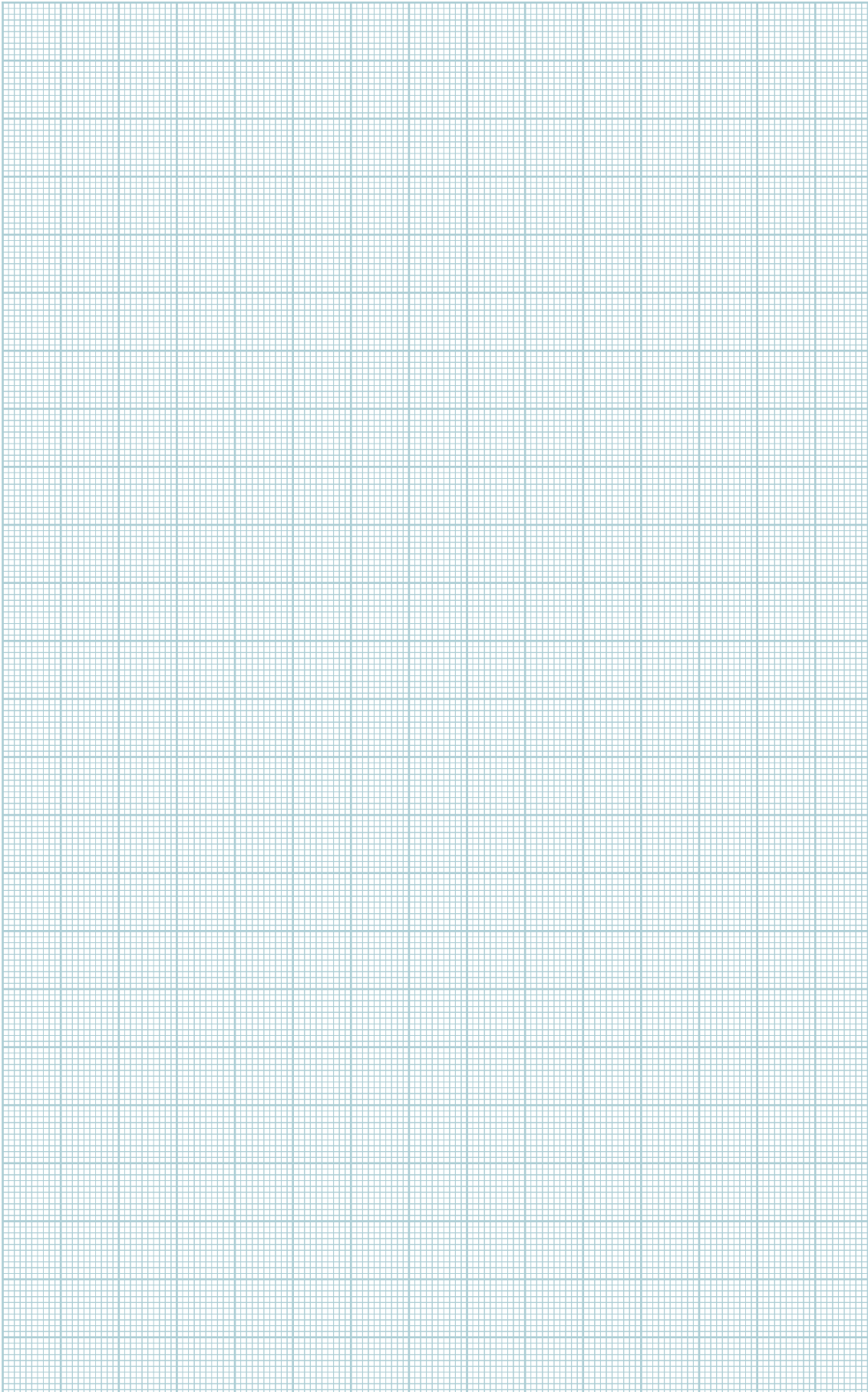

Notes

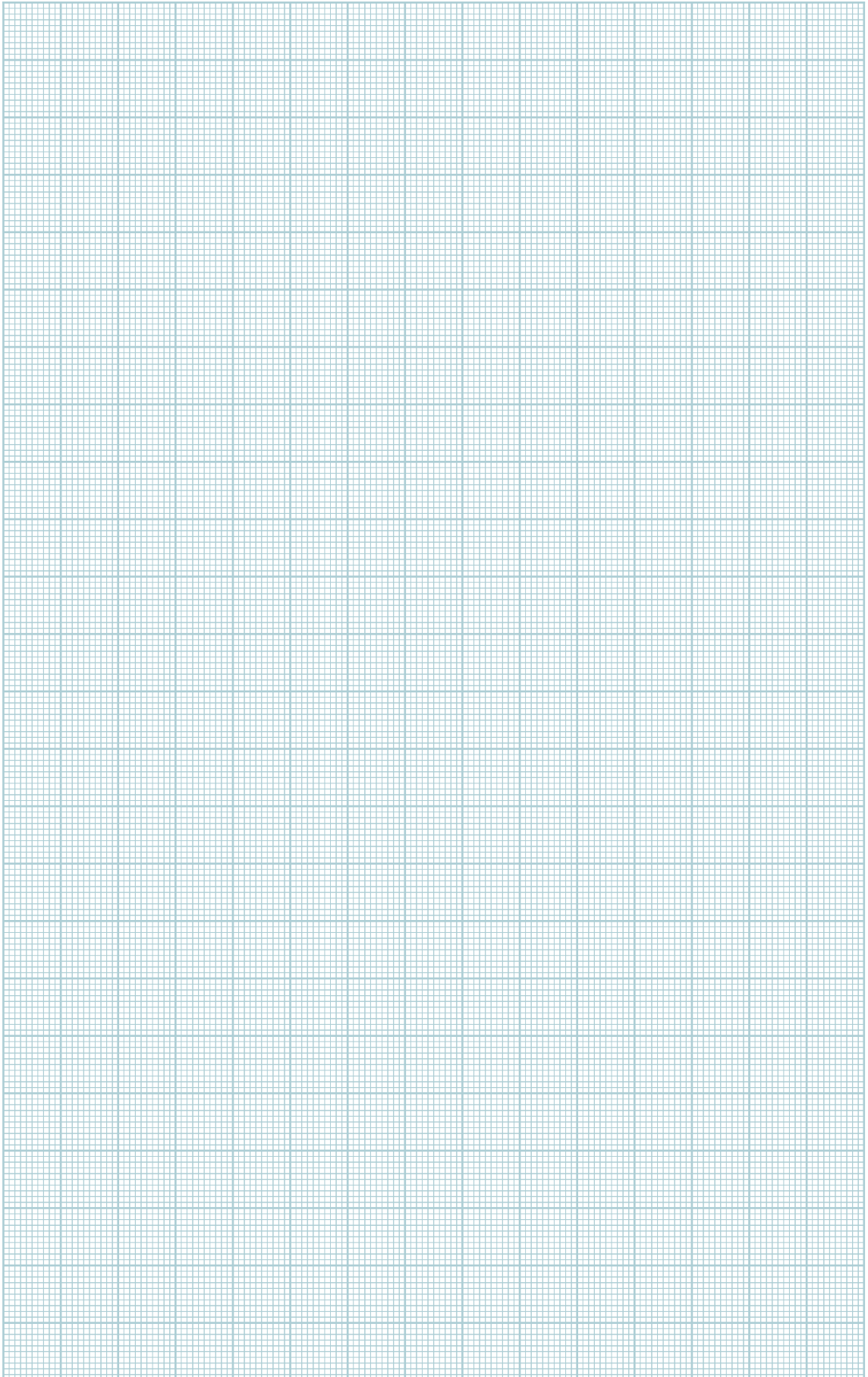

Notes

