



Automation

Activator



Limit switch

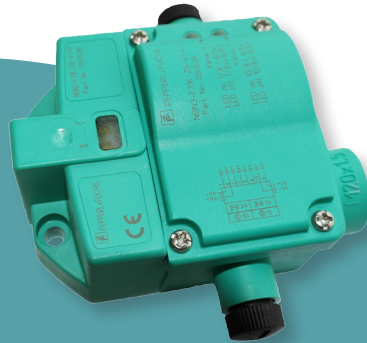

Cable gland



Pneumatic actuator

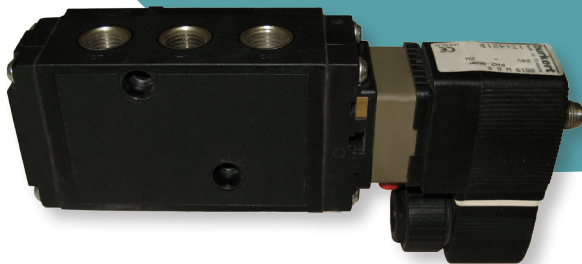

Solenoid valve

Connection cable

Activator



Limit switch



Cable gland



**Pneumatic
actuator**



Solenoid valve

Limit switch



Cable gland



Pneumatic actuator



Solenoid valve



Activator



Limit switch

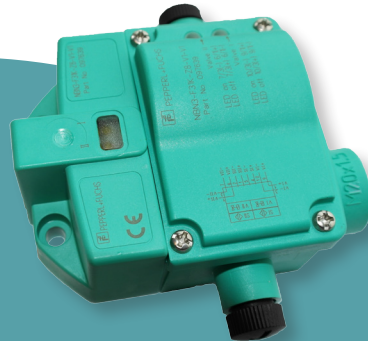

Cable gland

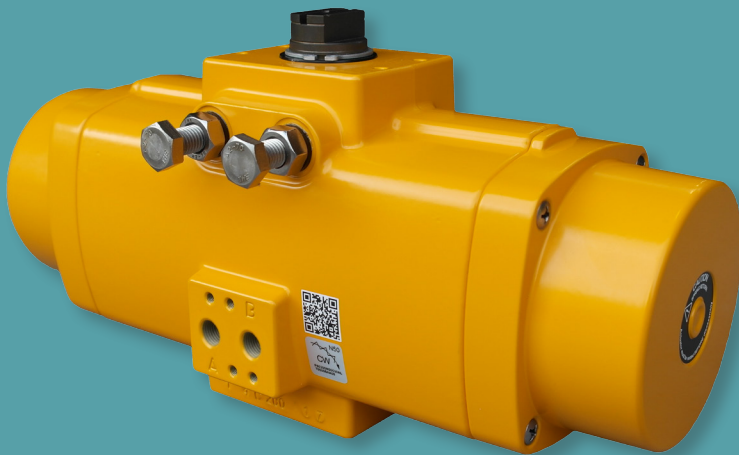

Pneumatic actuator

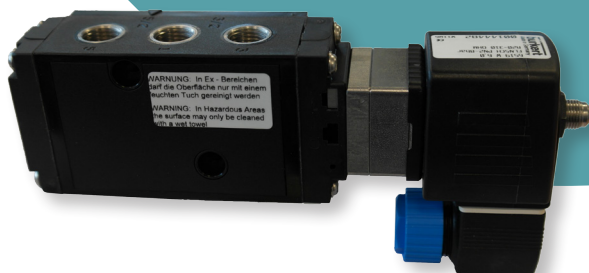

Solenoid valve

Connection cable

Activator



Limit switch



Splitter box



Pneumatic actuator



Solenoid valve

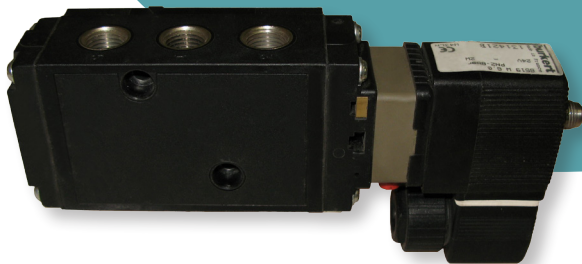

Connection cable



Ventilation tubes

Silencers & strainers

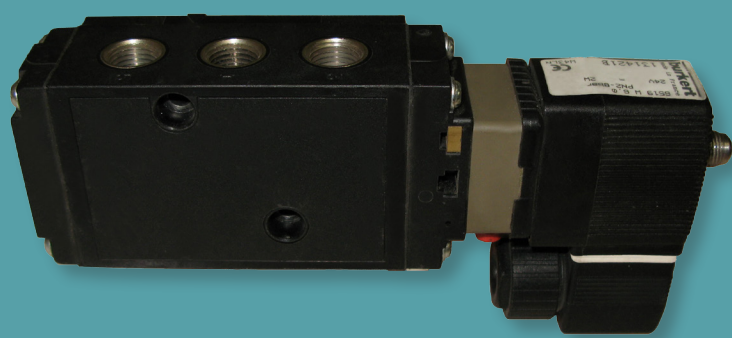

Speed controller

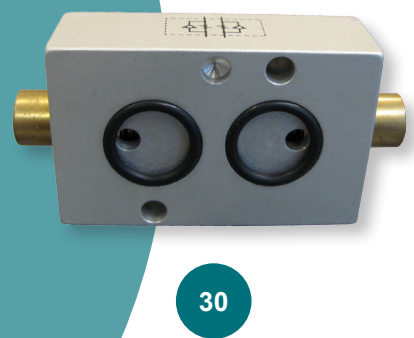





Adaptors





Blind stops



SILENCERS & STRAINERS

10		1/4": AF12021300 (brass)	1/8":
11		1/4": AF12081306	1/8":
12		1/4": AF12061300	1/8":
13		1/4":	1/8": AF12021000 (stainless steel)

VENTILATION TUBES

20		1/4": SODTUBE004	1/8": SODTUBE001
21		1/4": SODTUBE005	1/8": SODTUBE002
22		1/4": SODTUBE006	1/8": SODTUBE003
23		1/4":	1/8":
24		1/4":	1/8":
25		1/4":	1/8":

SPEED CONTROLLER

30		ELOVPX	ELOVPXI (stainless steel)
----	---	--------	------------------------------

ADAPTORS

41		1/4": AF13050813	1/8":
42		1/4": AF40101313	1/8": AF40101010
43		1/4": AF10010813 + AF10020800G	1/8":
44		1/4": AF10010813	1/8":

BLIND STOPS

50		1/4":	1/8":
51		1/4": AF40181301	1/8": AF40181001
52		1/4":	1/8":
53		1/4":	1/8":

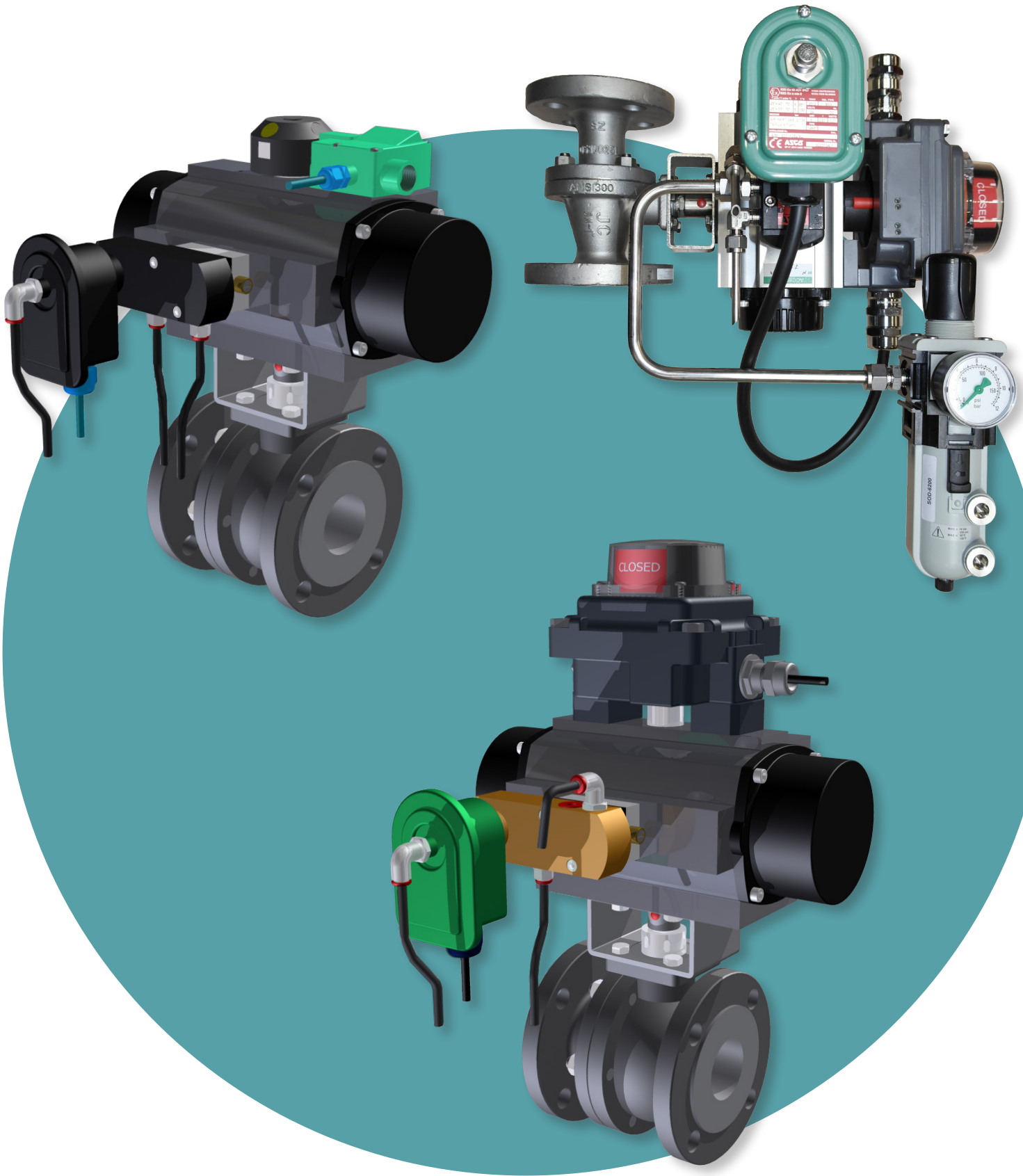

	LIMIT SWITCH	CABLE GLAND	SOLENOID VALVE	CABLE
24 VDC	2-wire: NBN3-F31K-Z8-V1-V1 (SD2166XX) 3-wire: NBN3-F31K-E8-V1-V1 (SD3166XX)	M20 x 1,5 CG (grey plastic)	MNAM 24 VDC	30 cm: VMA-2+P/Z2-0,3M-PVC-V1-W-Y VC 12A 60 cm: VMA-2+P/Z2-0,6M-PVC-V1-W-Y VC 12A
	Options: - number of connectors for solenoid valves: 0, 1 or 2 - other cable gland - speed controller fig. ELOVPX			
3G3D	2-wire: NBN3-F31K2M-Z8-B13-S-3G3D 3-wire: NBN3-F31K2M-E8-B13-S-3G3D	M20 x 1,5 CGEXE (black plastic)	MNAMXC	
	Options: - 24 VDC: 2-wire (NBN-F31K2-Z8-B13-S) or 3-wire (NBN-F31K2-E8-B13-S) - Eex i: NCN3-F31K2-N4-B13-S - ASI - Blind stop (no connection) - speed controller fig. ELOVPX			
Eex d	TXP-M2CGNMM (SXM9XXT)	M20 x 1,5 CGEXD (metal)	MNAMXC	-
	Options: - number of connectors for solenoid valves: 0, 1 or 2 - other cable gland - speed controller fig. ELOVPX			
Eex i	NCN3-F31K-N4-V1-V1 (SDI166XX)	M20 x 1,5 CGEXI (blue plastic)	MNAM I	V1S-W-N4-0,5M-PVC VC 12A EXi
	Options: - number of connectors for solenoid valves: 0, 1 or 2 - other cable gland - speed controller fig. ELOVPX			
ASI	NCN3-F31-B3B-V1-V1 SDA66XX	VAZ-T1-FK-G10-V1 (nieuw)	MNAM 24 VDC	VMA-2+P/Z2- (nieuw) 0,3M-PVC-V1-W eindeloop naar magneetventiel